



Relax. Rejuvenate. Refresh.

**THERAMIST**

Steam Showers

# *Steam Therapy*

## *Ancient Wisdom, Modern Luxury*

Steam therapy is not new, but the ease with which you can access the vast array of steam's benefits has never been greater. Theramist Steam Showers are the modern adaptation of the steam immersion ritual that has been used in many cultures for hundreds of years. The ability of steam to improve overall health, clear the mind and rejuvenate the spirit is well documented, and a Theramist Steam Shower effectively, affordably, and stylishly integrates this amazing therapy to your home.

### **Health - "Invest in You, Invest in Life"**

As we continue to lead busier and busier lives, it's imperative that we invest in ourselves - we need to rejuvenate and recharge more frequently. The small investment in a Steam Shower quickly pays off in many ways:

**Relaxation** - The most immediate benefit of time in a Theramist Steam Shower, a period of relaxation enables us to step out of the torrid pace of life and find a little tranquility, perhaps a little isolation, and a soothing environment.

**Sleep** - Without healthy, deep sleep the body cannot properly heal and is left in a state that is susceptible to illness. Poor sleep patterns often initiate a chain reaction of poor health - and this can be avoided with a daily session in your Theramist Steam Shower.

**Improved Circulation** - Circulation is literally our lifeblood - with increased circulation comes improved healing and detoxifying. Small injuries are overcome more efficiently and ongoing ailments find increased relief. The ever-increasing amount of toxins we are exposed to daily are flushed from our bodies, and nutrients are delivered to tissues in need more effectively.

**Stress Relief** - Stress is unavoidable, but we can remove stress by-products and renew the spirit with a short steam shower session. "Feel good" brain endorphins increase in production and a general feeling of well-being will emerge after a Theramist Steam Shower session.

**Cognitive Function** - Those who cope with stress more efficiently, that get adequate sleep and who are not battling illness are often able to be more productive, stay on task longer and be more positive contributors to the activities they engage in.

**Skin Health** - Steam has long been used to exfoliate and rejuvenate the skin. Theramist Steam Showers naturally moisturize the skin while increased circulation brings nutrients to supply healthy growth. Avoid expensive chemical solutions and enjoy this ancient, natural method for beautiful, youthful skin.



# CS 2246

This beautiful and compact corner unit provides you with all the features in a space-saving design. Perfect for individual use, you'll discover that this model has a lot to offer.

## Features:

- AM/FM Radio
- CD Stereo Input
- Hands-Free Telephone
- Time/Temperature Control
- Digital Interface  
w/Remote Control
- Ceiling & Spot Light
- Steam Generator
- 6 Back Hydro-Massage jets
- Overhead Rain Shower
- Detachable Shower Head
- Foot Massager
- Alarm/Exhaust Fan
- Ozone Disinfection

37.50" x 37.50" x 84.75"  
95cm x 95cm x 215cm  
Weight: 155kg (342lbs)

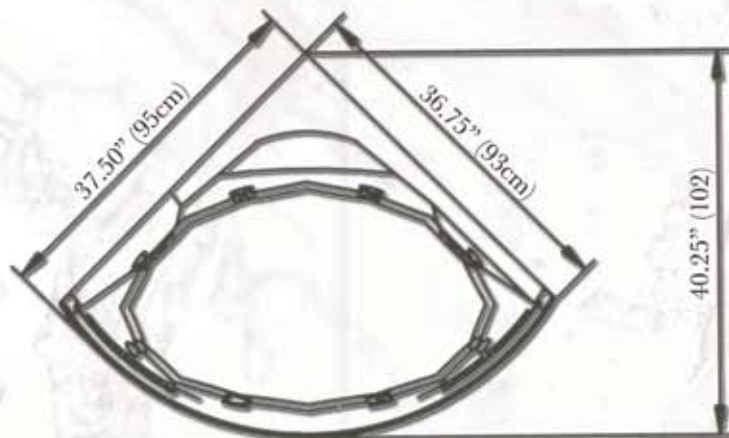
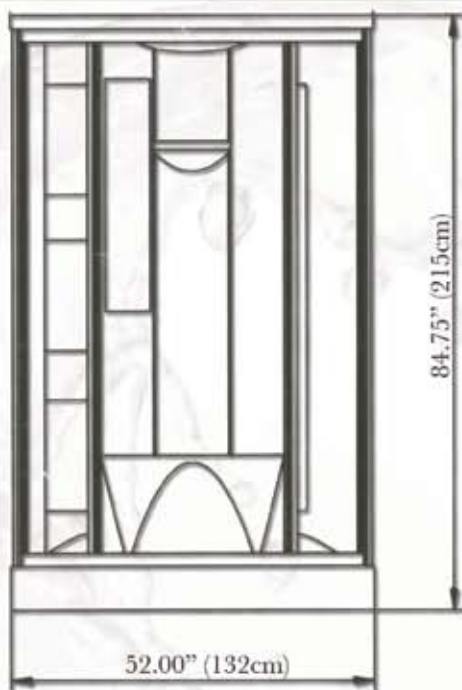

# CS 2206

This compact design tucks away beautifully into a corner to add to a room's esthetic appeal, not overwhelm it. Consideration has still been given to comfort as this unit allows you to sit and relax while enjoying all the bells and whistles.

## Features:

- AM/FM Radio
- CD Stereo Input
- Hands-Free Telephone
- Time/Temperature Control
- Digital Interface  
w/Remote Control
- Ceiling & Spot Light
- Steam Generator
- 6 Back Hydro-Massage jets
- Overhead Rain Shower
- Detachable Shower Head
- Foot Massager
- Alarm/Exhaust Fan
- Ozone Disinfection

42.25" x 42.25" x 88.75"  
107cm x 107cm x 225cm  
Weight:

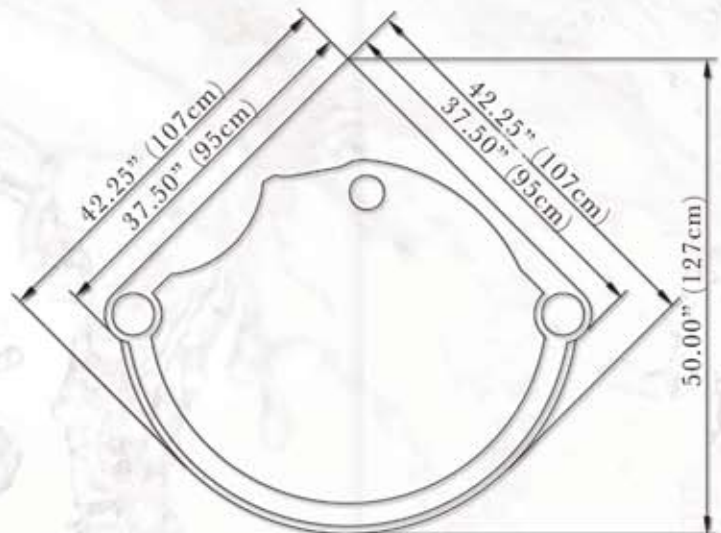
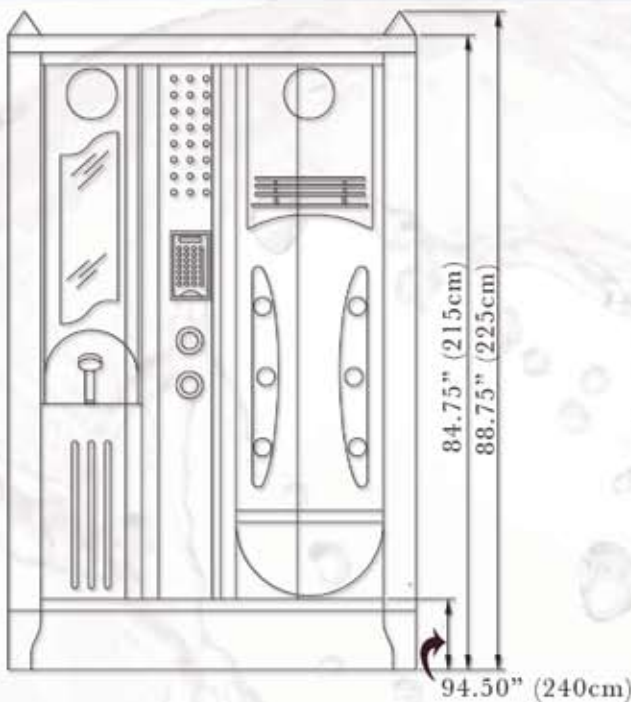

# CS 46

This beautiful corner unit is perfect for individual use. Tinted glass gives you privacy with an open feel.

## Features:

- AM/FM Radio
- CD Stereo Input
- Hands-Free Telephone
- Time/Temperature Control
- Digital Interface
  - w/Remote Control
- Ceiling & Spot Light
- Steam Generator
- 6 Back Hydro-Massage jets
- Overhead Rain Shower
- Detachable Shower Head
- Foot Massager
- Alarm/Exhaust Fan
- Ozone Disinfection



39.50" x 39.50" x 83.50"  
101cm x 101cm x 212cm  
Weight: 150kg (331lbs)

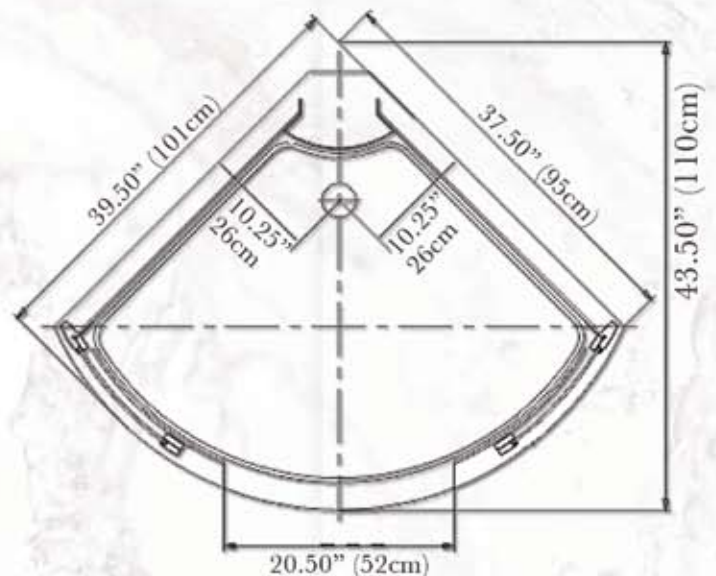
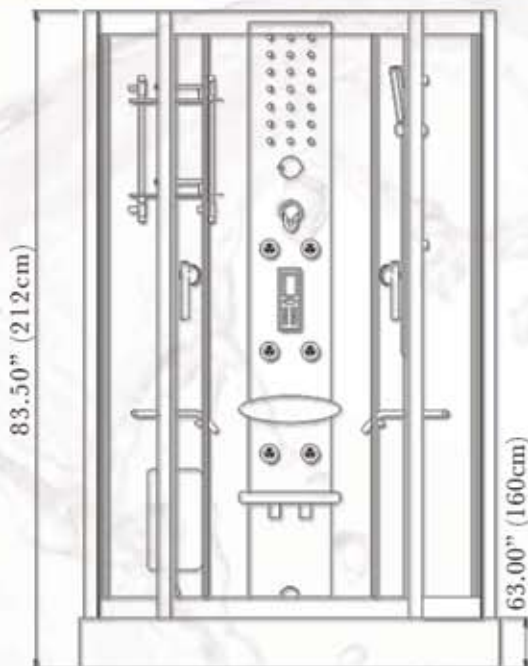

# RS 14

This compact unit fits perfectly in more limited spaces and still offers you all the benefits of any of the larger models. Enjoy the rain shower, handheld shower, & steamer while enjoying the privacy offered by the tinted glass.

## Features:

- AM/FM Radio
- CD Stereo Input
- Hands-Free Telephone
- Time/Temperature Control
- Digital Interface
  - w/Remote Control
- Ceiling & Spot Light
- Steam Generator
- 4 Back Hydro-Massage jets
- Overhead Rain Shower
- Detachable Shower Head
- Foot Massager
- Alarm/Exhaust Fan
- Ozone Disinfection

57.75" x 34.00" x 84.75"  
147cm x 87cm x 216cm  
Weight: 180kg (397lbs)

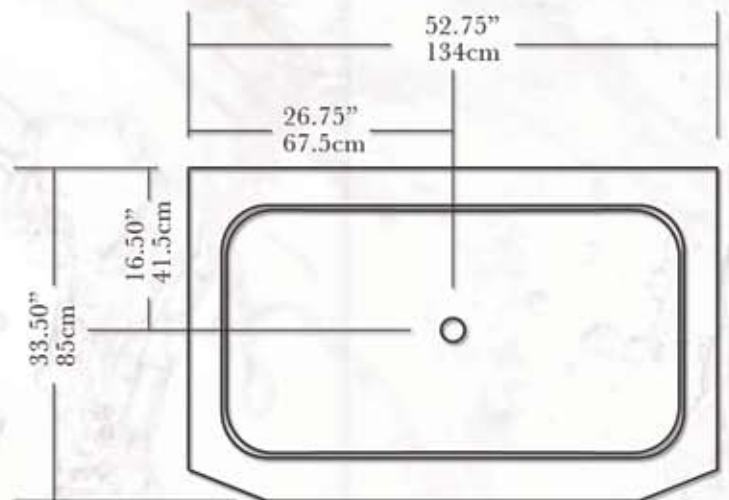
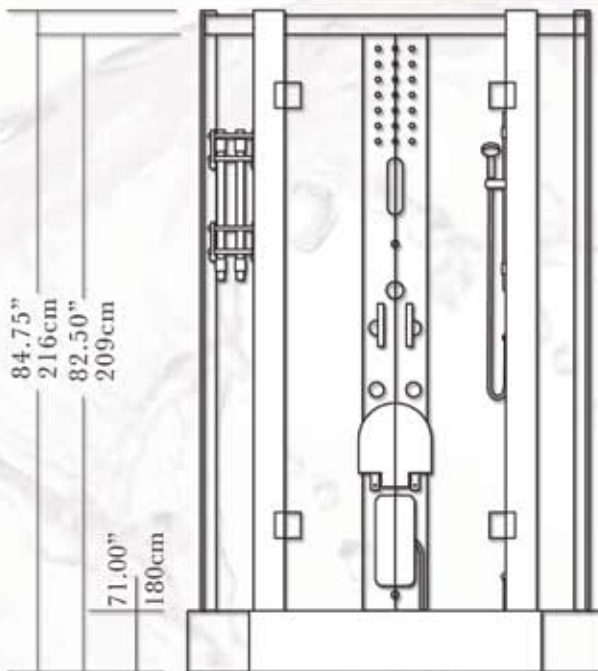

# RS 2218

Glass front & sides create an open and spacious feeling while enjoying this single-seat unit. Includes a utility sink to make for a very versatile cleansing experience.

## Features:

- AM/FM Radio
- CD Stereo Input
- Hands-Free Telephone
- Time/Temperature Control
- Digital Interface  
w/Remote Control
- Ceiling & Spot Light
- Steam Generator
- 4 Back Hydro-Massage jets
- 5 Tri-Spray Jets
- Overhead Rain Shower
- Detachable Shower Head
- Foot Massager
- Alarm/Exhaust Fan
- Ozone Disinfection

51.25" x 36.25" x 88.00"  
130cm x 92cm x 223cm  
Weight: 125kg (276lbs)

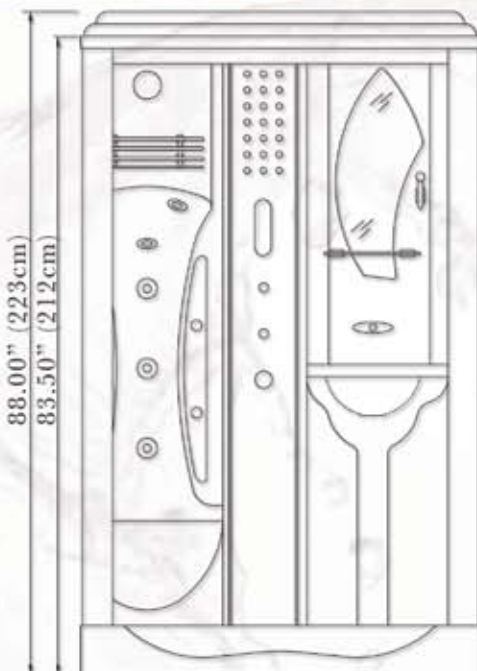

## *Home - “Your Best Investment Value”*

For most people, your home will be far and away the largest purchase you will ever make. The investment in upgrading your home can add a significant value and nowhere in your home is that investment better realized than in the bathroom. In fact, bathroom upgrades are the one and only area that pays back more than they cost. Theramist Steam Showers offer a simple, cost-effective and easily-installed upgrade that add that “wow!” factor to your new bathroom. To make things even easier, Theramist Showers are completely self-contained so they can be installed nearly anywhere. Hot and cold supply, 110 V electrical, and a drain is all you need so this luxury can be yours. Your own home spa is within reach for everyone!

Clean modern lines, luxurious surfaces and dazzling light and sound systems give your new bathroom an air of refinement and style. Friends and visitors will admire this beautiful addition to your home and will feel (and look!) like they visited an indulgent five-star hotel spa.

### *Theramist Steam Showers are loaded with features such as:*

#### **Chromotherapy Lighting Systems**

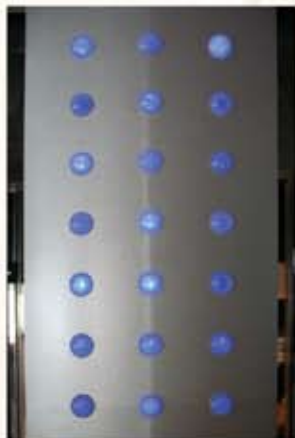

Multi-plane color changing light systems set the mood and soothe your senses.

#### **Multi-port Body Showerheads**



Seated or standing, pinpoint stress points, or enjoy a full massage from the multiple nozzles.

#### **Rainshower Showerhead**



High volume overhead shower to drench the body in a deluge of warm water, or a refreshing cool down after your steam.

#### **Hand-held Massage Showerhead**



Use the high volume massage wand to target large muscle groups or give the best neck massage you've ever had.



## Solid State Controls



Handsfree Phone - Never interrupt your steam to check the phone, take the call, or not!

AM/FM Radio with Input for Multimedia Devices - Integrated music systems to relax or invigorate are at your fingertips

Ozone System - Use the power of active oxygen to naturally and automatically sanitize your steam

### Shower Foot Massage Pad



Reactivate tired feet with stimulating water massage in the perfect position. Stores conveniently on the wall when not in use.

### Ergonomic Seating



Moulded seating cradles your body perfectly, letting steam and water work their magic! Lean back and be transported...

### Stylish Modern Design



Luxurious surfaces, blended with quality modern fixtures, add up to impressive design.

### Stereo Sound System



High quality stereo sound system with moisture-resistant speakers provide clear sound as you enjoy a steam or shower.

# CS 2212

This is an absolutely stunning unit. Designed for double-occupancy, this is perfect for the couple who wishes to enjoy some stress relief together.

## Features:

- AM/FM Radio
- CD Stereo Input
- Hands-Free Telephone
- Time/Temperature Control
- Digital Interface  
w/Remote Control
- Ceiling & Spot Light
- Steam Generator
- 14 Back Hydro-Massage jets
- Overhead Rain Shower
- Detachable Shower Head
- Foot Massager
- Alarm/Exhaust Fan
- Ozone Disinfection

56.00" x 56.00" x 91.00"  
142cm x 142cm x 231cm  
Weight:

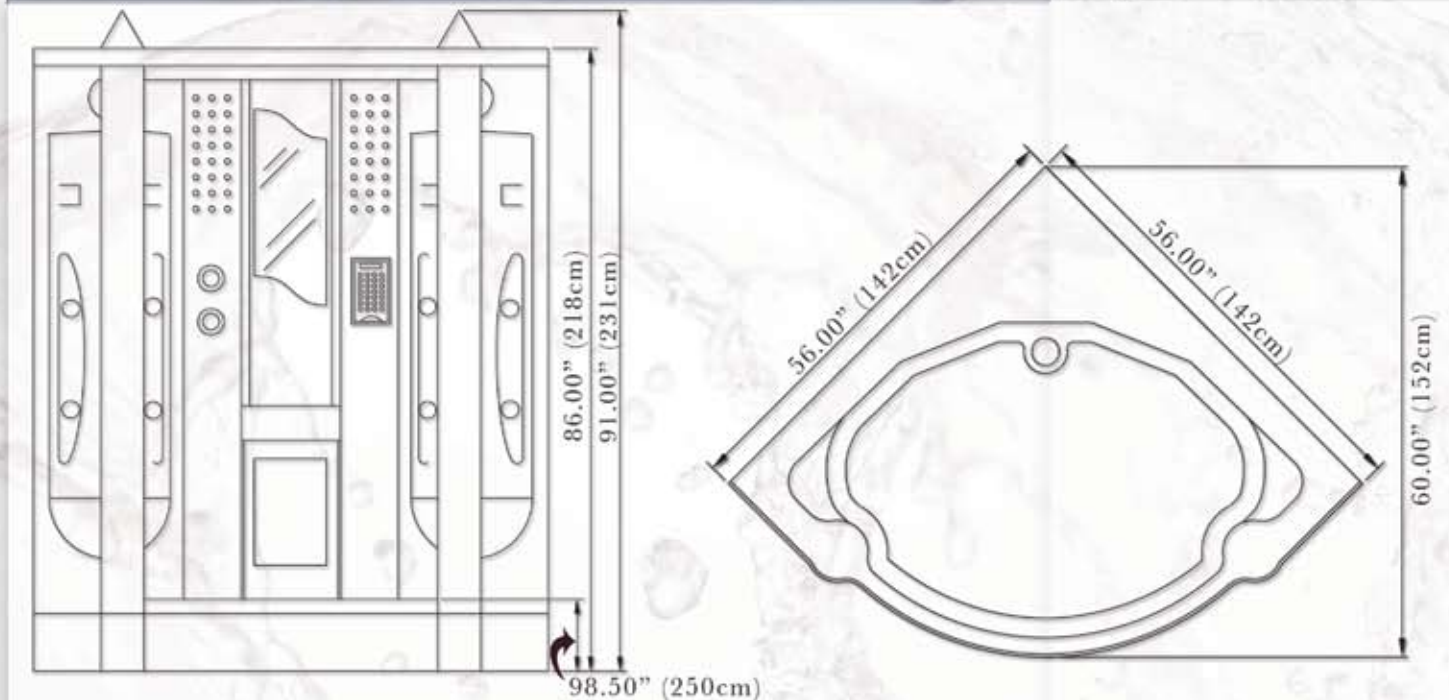

# RB 2236

This stand-alone jetted tub comes with all the amenities to allow you to choose your style of cleansing. Whether it's a soak in the tub, a nice hot shower or a detoxifying steam, you can be certain to feel fully refreshed every time.

## Features:

- AM/FM Radio
- CD Stereo Input
- Hands-Free Telephone
- Time/Temperature Control
- Digital Interface  
w/Remote Control
- Ceiling & Spot Light
- Steam Generator
- 4 Back Hydro-Massage jets
- 3 Tri-Spray Jets
- 13 Underwater Jets
- Overhead Rain Shower
- Detachable Shower Head
- Foot Massager
- Alarm/Exhaust Fan
- Ozone Disinfection
- Underwater Light

64.00" x 36.00" x 88.75"  
162cm x 91cm x 225cm  
Weight: 180kg (397lbs)

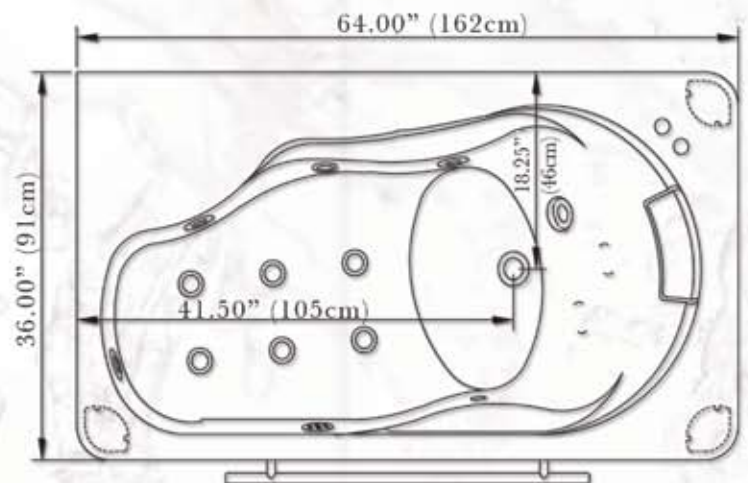
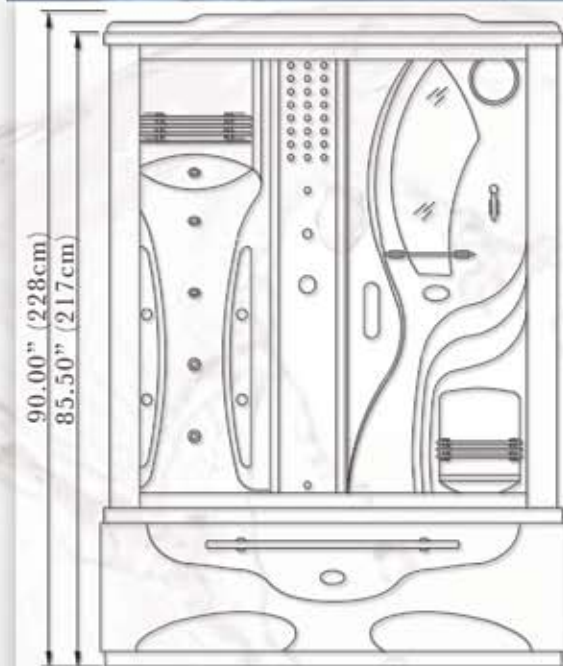

# CB 2208

This spectacular design allows you to do it all, and to do it together! Spaciously designed for double-occupancy, this corner unit will compliment any floorplan.

## Features:

- AM/FM Radio
- CD Stereo Input
- Hands-Free Telephone
- Time/Temperature Control
- Digital Interface  
w/Remote Control
- Ceiling & Spot Light
- Underwater Light
- Steam Generator
- 12 Back Hydro-Massage jets
- Overhead Rain Shower
- Detachable Shower Head
- Foot Massager
- Alarm/Exhaust Fan
- Ozone Disinfection
- Overflow Protection

61.00" x 61.00" x 91.00"  
155cm x 155cm x 231cm  
Weight:

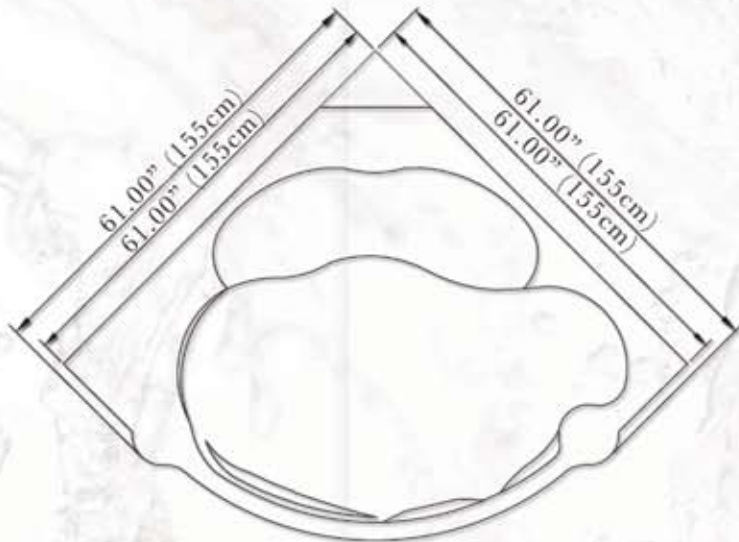
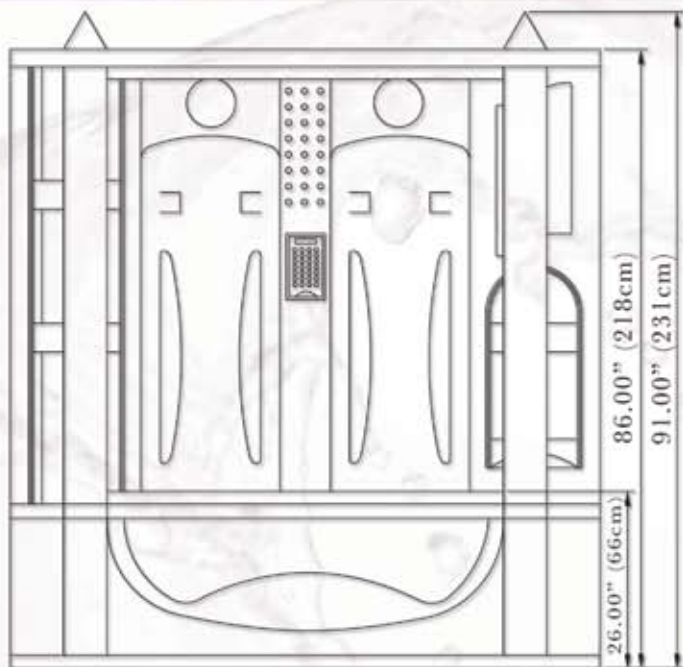

# RB 20

This design allows you to enjoy a soak in the tub, a hot shower, or a relaxing steam. A spacious unit with beautiful tinted glass allows you to enjoy alone or share.

## Features:

- AM/FM Radio
- CD Stereo Input
- Hands-Free Telephone
- Time/Temperature Control
- Digital Interface
  - w/Remote Control
- Ceiling & Spot Light
- Steam Generator
- 6 Back Hydro-Massage jets
- Overhead Rain Shower
- Detachable Shower Head
- Foot Massager
- Alarm/Exhaust Fan
- Ozone Disinfection

59.25" x 35.50" x 84.75"  
150cm x 90cm x 215cm  
Weight: 197kg (435lbs)

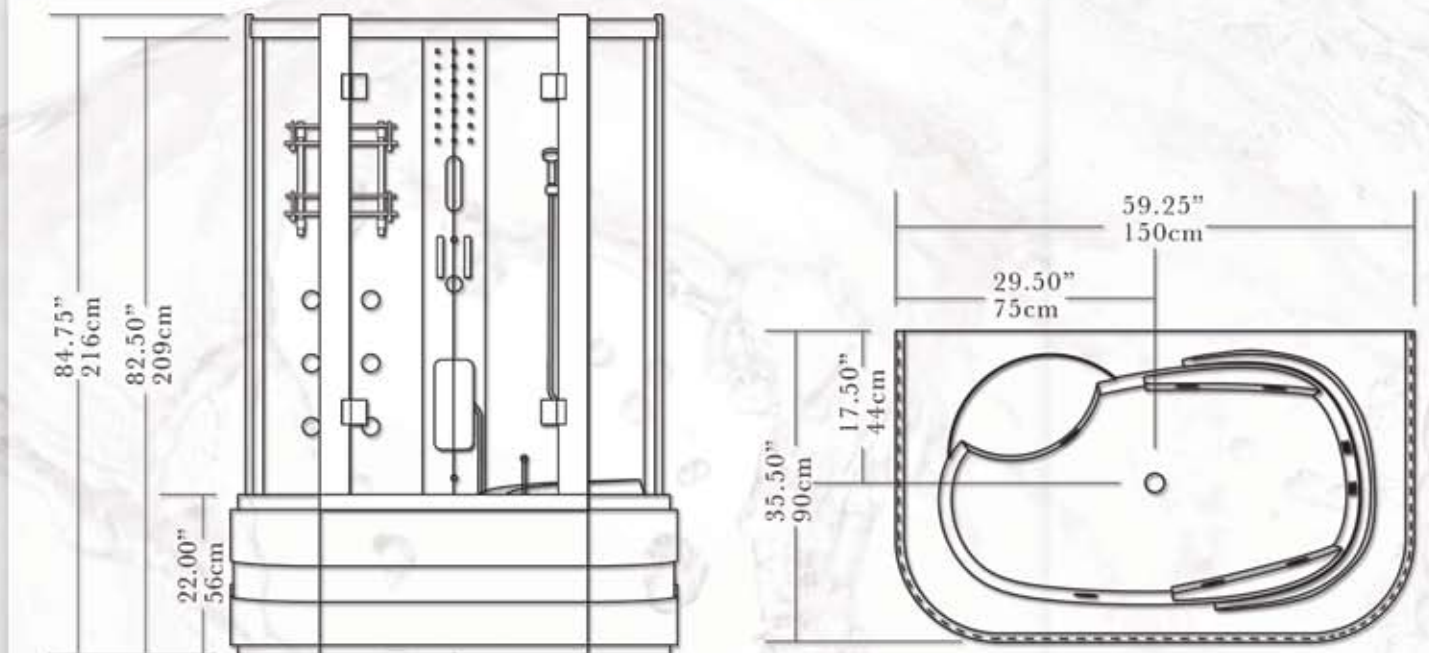

# RS 32

A truly unique design allows you to sit back while you cleanse. Perfect for those with mobility pain, such as recovering from an injury.

## Features:

- AM/FM Radio
- CD Stereo Input
- Hands-Free Telephone
- Time/Temperature Control
- Digital Interface
  - w/Remote Control
- Ceiling & Spot Light
- Steam Generator
- 8 Back Hydro-Massage jets
- Overhead Rain Shower
- Detachable Shower Head
- Foot Massager
- Alarm/Exhaust Fan
- Ozone Disinfection

81.50" x 43.75" x 86.00"  
207cm x 112cm x 219cm  
Weight: 250kg (551lbs)

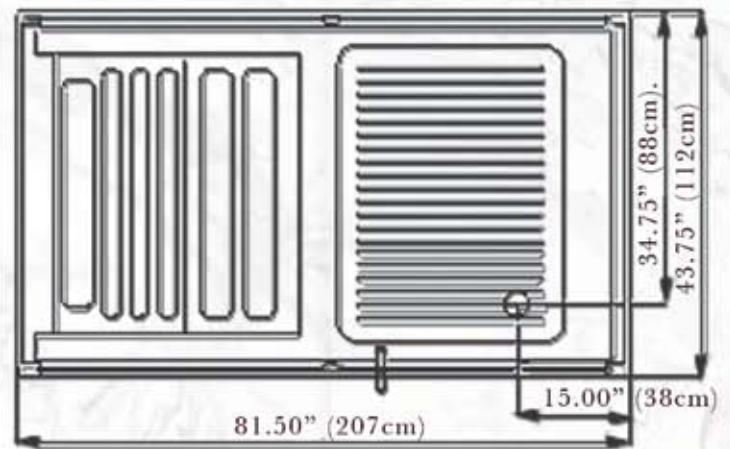
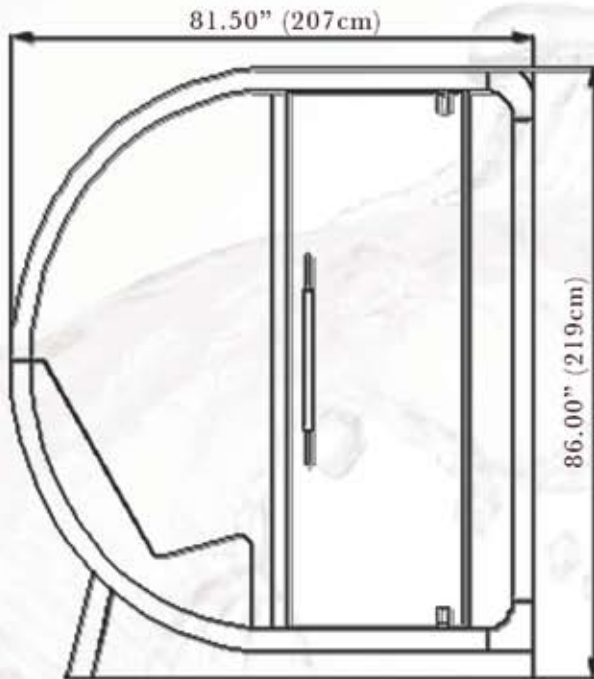

***Naturally Beautiful Skin begins Here***

Start your family on the path of amazing skin health with the investment in a Theramist Steam shower. Forget expensive and overpriced lotions and treatments and get back to basics - time in the steam environment will exfoliate, rejuvenate and invigorate your entire family.



***Happy, Healthy Family for Life***

The addition of a Theramist Steam Shower will create the most loved room in your home. All family members, young and old will find that time spent in the steam environment will have a benefit to them,

and as they do, the overall health of your family will increase. What better investment can you make than in the health of your entire family! Long, happy and healthy lives can all begin with a Theramist Steam Shower.

*Theramist may make product modifications and enhancements without notice. Specifications and dimensions are approximate and for reference only.*



*Steam Showers*